

WEDA Pump Brochure

RL Series



WEDA PUMP

A long experience in designing, manufacturing, and marketing pumps has made WEDA PUMP one of the few major submersible pump manufacturers worldwide. Relying on a well-established and growing international network of distributors, **WEDA PUMP offers fast delivery, international warranty and unchallenged service of all RL submersible pumps, wherever our customers might be located.**

WEDA PUMP submersible drainage pumps offer **an extensive choice of pumps** suitable for a large scope of pumping applications: from light industrial use up to the most heavy-duty applications.

WEDA PUMP RL pumps are of centrifugal type. They are primarily designed for drainage of leakage water on construction sites or in the mining industry, but they are widely used in other applications like utilities, the process industry, ship yards, fire brigades and in the navy.

With connection diameter from 2 inches to 10 inches, and maximum capacity from 600 l/mn up to 18 000 l/mn, **the WEDA RL pumps are known among pumps professionals and rental companies as reliable equipment when it comes to pumping lightly contaminated water.** The quality of our pumps' components is combined with a **plug-and-pump design** and an **optimized serviceability and working life** to offer our customers the best possible quality/cost ratio, therefore **a good investment for contractors and rental companies.**



WEDA DRAINAGE PUMPS' OPTIMUM



- **Optimum 1: models designed for professionals**
our commitment to offering the best possible quality/cost ratio involves that our pumps are made with components and material suitable for professional use. Demanding applications like in civil-engineering and mines or utilities can only be fulfilled with high quality standards; and that is what the RL submersible pumps offer.



- **Optimum 2: plug-and-pump design.**
The WEDA RL pumps are self-priming. No priming operation is necessary as with other types of pumps like the motor-driven models. Pumping can start automatically owing to the optional self-starting devices: float switch on the smallest models (RL 2010, RL 2030, RL 4140), NVB electronic level control (for RL 4150 to RL 6090).



- **Optimum 3: user-friendliness.**
We have designed our pumps with user-friendliness in mind combining aluminium as the main material for the pump casing and our specific compact design resulting in light-weight equipment. Handling, installation and service of the RL pumps are therefore much easier than for pumps with a traditional cast iron body.



- **Optimum 4: Serviceability.**
The unique sealing system of our pumps makes them easy to maintain and service. Only a few operations allows to change the seals most often on site in a few minutes, thus reducing down-time and costly service operations and transport.



1/ Fire brigade couplings



2/ Threaded discharge



3/ Stainless steel strainers



4/ Floor level band



• **Optimum 5: Permanent cooling of the electric motor.**

The WEDA PUMP design featuring the medium passing between the inner and outer casing ensures proper motor cooling as long as the pumps is working at full capacity.



• **Optimum 6: Versatility**

WEDA PUMP does not only manufacture standard pumps, but also designs special accessories that will optimize the use of our pumps when our customers have specific needs.

You may refer to our Technical data chart on page 6 for detailed information about the various options available for each model (level float switch, NVB electronic level control, zinc anodes or epoxy painting to avoid corrosion, delta/star start, time relay for delayed start). We also supply **fire brigade couplings** (n°1), or **threaded discharge 2** in (for our RL 2014 model) and 2.5 in diameters (for our RL 2032, RL 2034 and RL 4144) (n°2). To avoid pumping dirty water or reducing the content of solid particles that is being pumped, special **stainless steel strainers** are also available for our pump models RL 2014, RL 2032, RL 4144 (n°3). **Floor level band** are used when pumping the water at the lowest possible level is necessary (pumping water from the bottom of a cellar for example). Instead of pumping the water down to 20/25 mm which is normally the case with standard pumps, this floor level band will allow to pump the water as low as a few mm only (n°4).

We design our pumps to make your life easier!

- ① RL pumps impeller is made of chrome alloy steel with a hardness of 550 HBr along **the highest quality standards on the market.**
- ② Wear plates and diffusor are made of nitril rubber NBR, **particularly resistant** to chemical and oil.
- ③ Aluminium **extra light** casing for the RL 2010, RL 2030, RL 4140, RL 4150, RL 4060. Galvanized steel casing for the RL 6070, RL 6090 and RL 8010.
- ④ All shafts, screws, nuts and washers made of stainless steel to **avoid corrosion.**
- ⑤ **Highly reliable motor:**
 - 2 pole for all models, except the RL8010 which has a 4-pole motor
 - class F insulation (155°C)
 - Excellent protection against over heating: thermal protectors (130 °) in the winding connected to the contactors stopping the motor when an overload or overheating occurs.

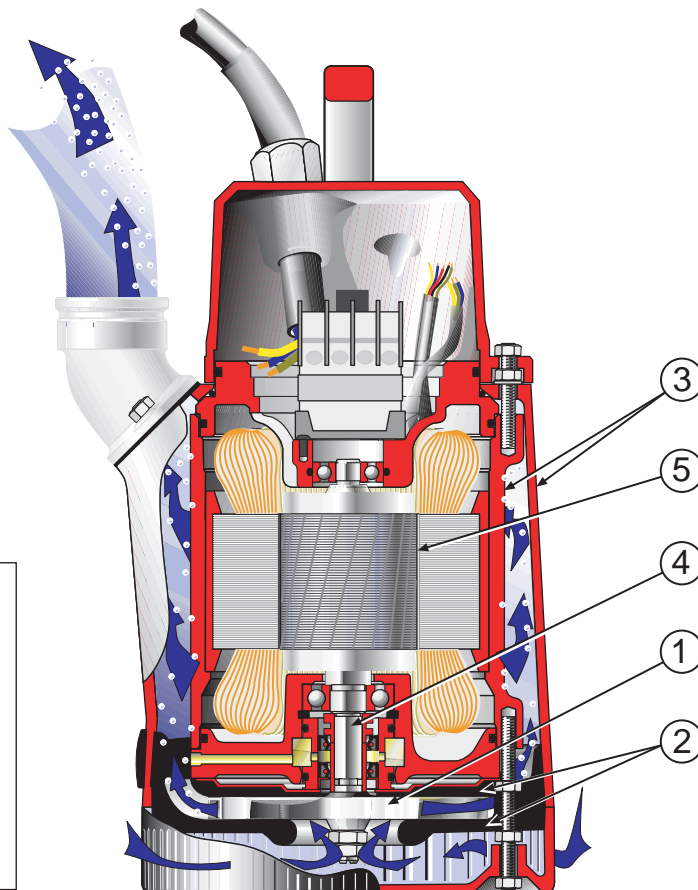

A SEALING SOLUTION SPECIALLY DESIGNED FOR EACH TYPE OF PUMP:



The RL 2110 sealing device: easy to change in a few minutes only!



The RL 2030 and RL 4140: a built-into the pump sealing device.



Sealing device for our bigger RL models.

We design our pumps to make them lighter and easily serviceable.

Economy and convenience are two key words when we, at WEDA PUMP, design and manufacture our RL pumps. Contrarily to some of our competitors, we have taken the option not to equip our smallest models (RL2010, RL2030 and RL4140) with a dual mechanical seal device. Our model RL2010 has no mechanical seal, while the RL2030 and RL4140 simply have a primary mechanical seal. **The dual mechanical seal is indeed unnecessary on these small models where the shaft is thinner. Our experience of thousands of RL pumps sold without any sealing problem has proven that these lighter pumps are much easier, faster and cheaper to service.**

Our customers in the rental industry, construction business, in utilities and fire brigades always appreciate our technical choices in terms of sealing for the low down-time they have with the RL pumps and the fast service operations that can be performed on site within a few minutes.

The RL2010 is sealed with a small complete unit of aluminium, with 2 lip seals; the wearing sleeve made of hard metal on the shaft rotates against the lip seals. This complete sealing unit is filled up with grease, which combined with the wearing sleeve, lengthens the part's lifetime. **This sealing device is probably the best on the market for smaller pumps** as it features a long and trouble-free operating life, fast and inexpensive service, besides allowing **a gain in the pump's weight. WEDA PUMP unique sealing design, allowing substantial economies in terms of service** (both from the point of view of labour cost and of spare parts cost) **is a major advantage especially for rental companies.**

A built-in design for the **RL2030 and RL4140. A lip seal on the motor's side is combined with a silicon carbide seal in contact with the water.** The sealings are included in an aluminium casing together with the lower bearing and oil. This "built-into the pump" sealing design offers many advantages in terms of weight, allowing a simple and compact pump design and long-working life.

On our bigger models: **RL4150 and upward, mechanical seals of silicon carbide both on the motor and on the water side are built into a complete sealing together with oil and bearings.** The RL4150 and RL4060 feature a single bearing while RL6070 features dual bearings. A pressure-compensation rubber oil bag completes the sealing device. This complete sealing unit can be easily replaced, therefore allowing a very limited down-time when seal replacement is needed.

WEDA PUMP GUIDE TO PUMPING

TECHNICAL DATA

	RL 2010	RL 2030	RL 4140	RL 4150	RL 4060	RL 6070	RL 6090	RL 8010
Pump								
Connection dia. in - (mm)	2" - (50)	3" or 4" - (80 or 100)	3" or 4" - (80 or 100)	4" or 3" - (100 or 80)	4" or 3" - (100 or 80)	6" or 4" - (150 or 100)	6" or 4" - (150 or 100)	10" - (255)
Connections for hose alt BSP alt NPT	yes-yes-yes	yes-yes-yes	yes-yes-yes	yes-yes-yes	yes-yes-yes	yes-yes-yes	yes-yes-yes	yes-yes-yes
Max. total head m - (ft)	15.1 - (51)	14.5 - (48)	20.5 - (67)	14 - (46)	30 - (98)	35 - (115)	45 - (148)	42.5 - (139)
Maximum capacity l/mn - (m3/h)	600 - (36)	1 500 - (90)	1 610 - (96)	3 000 - (180)	3 400 - (204)	4 700 - (282)	6 300 - (378)	19 000 - (1 140)
Suitable for media with pH	5 - 8	5 - 8	5 - 8	5 - 8	5 - 8	5 - 8	5 - 8	5 - 8
Max. water temperature	40°C - 104°F	40°C - 104°F	40°C - 104°F	40°C - 104°F	40°C - 104°F	40°C - 104°F	40°C - 104°F	40°C - 104°F
Max. submersible depth m - (ft)	20 - (65.6)	20 - (65.6)	20 - (65.6)	20 - (65.6)	20 - (65.6)	20 - (65.6)	20 - (65.6)	20 - (65.6)
Max. size of solid particles mm - (in)	4 - (0.15)	9 - (0.35)	9 - (0.35)	6 - (0.23)	6 - (0.23)	7 - (0.27)	7 - (0.27)	12 - (0.47)
Built in starter, contactor, motor protect	yes	yes	yes	yes	yes	yes	yes	no
Options available								
Other impeller versions, total head m-(ft)	no	23.5 - (77)	no	27 - (88)	no	no	no	no
Max capacity l/mn - (m ³ /hr)		800 - (48)		1200 - (72)				
Other impeller versions, total head m-(ft)	no	no	no	43 - (141)	52 - (172)	80 - (262)	85 - (279)	no
Max capacity l/mn - (m ³ /hr)				1050 - (63)	650 - (39)	1000 - (60)	1750 - (105)	
Level float switch	Yes	Yes	Yes	No	No	No	No	No
NVB elec. level control	No	No	No	Yes	Yes	Yes	Yes	No
Zinc anodes (anti-corrosion protection)	Yes	Yes	Yes	Yes	Yes	Yes	Yes	Yes
Floor level hand	Yes	Yes	Yes	No	No	No	No	No
Star/delta starter	No	No	No	No	No	Yes	Yes	starter box with or without D/S
Time relay for delayed start	No	No	No	No	No	Yes	Standard	No
Stainless steel strainer	Yes	Yes	Yes	Standard	Standard	Standard	Standard	Galvanized steel
Over current relay	No	No	No	Yes	Yes	Yes	Standard	No
Motor*								
Nominal shaft power kWx - (hp)	1 - (1.34)	2 - (2.7)	3 - (4)	4.7 - (6.3) Low/med. Head 5.4 (7.2) High Head	7.5 - (10)	11.8 - (15.8)	26.5 - (35.5)	54 - (72.4)
Rated electrical power (kW) - (hp)	1.4 - (1.87)	3 - (4)	3.6 - (4.8)	6.3 - (8.4) Low/med. Head 7.3 - (9.8) High Head	9.8 - (13.1)	14.5 - (19.4)	32 - (43)	63 - (84.5)
Speed (RPM)	2990	2990	2990	2990	2990	2990	2990	1450
Stator insulation class	F(155°C - 311°F)	F(155°C - 311°F)	F(155°C - 311°F)	F(155°C - 311°F)	F(155°C - 311°F)	F(155°C - 311°F)	F(155°C - 311°F)	F(155°C - 311°F)
Motor protection temp.	130°C	130°C	130°C	130°C	130°C	130°C	130°C	130°C
Overall dimensions								
Dia x w x h (mm)	183 x 217 x 380	(Low head) 217 x 310 x 475 (Medium head) 217 x 310 x 500	317 x 310 x 475	277 x 330 x 708	(Low head) 277 x 330 x 760 (High head) 312 x 330 x 810	360 x 410 x 915	410 x 452 x 1080	600 x 600 x 1435
Dia x w x h (in)	7.2 x 8.5 x 15	(Low head) 8.5 x 12.2 x 18.7 (Medium head) 8.5 x 12.2 x 19.7	8.5 x 12.2 x 18.7	10.9 x 13 x 27.9	(Low head) 10.9 x 13 x 30 (High head) 12.2 x 13 x 32	14.1 x 16.1 x 36	16.1 x 17.8 x 42.5	23.6 x 23.6 x 56.5
Weight excluding cable kg - (lbs)	12.5 - (27.5)	20 - (44.1)	25 - (55)	55 - (121) <i>For low and medium head 63 - (139) For RL 4156 and RL 4157</i>	55 - (121) <i>For low and medium head 63 - (139) For RL 4066 and RL 4067</i>	95 - (210)	180 - (397)	510 - (1125)

*Voltages available: see information about each model of pump.

WEDA PUMP GUIDE TO PUMPING

RL 2010

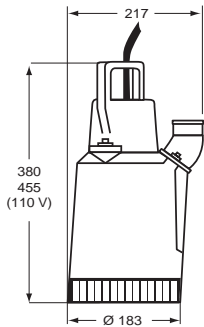

Dimension in mm.

RL 2030

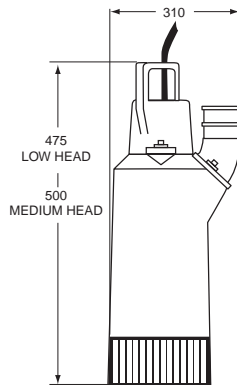

RL 4140

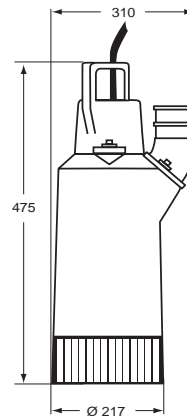

Dimension in mm.

RL 4150

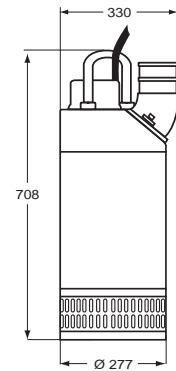

RL 4060

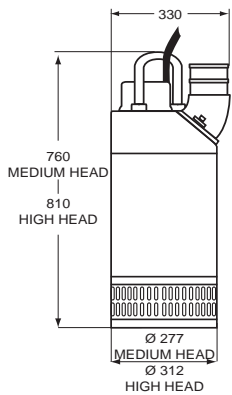

Dimension in mm.

RL 6070

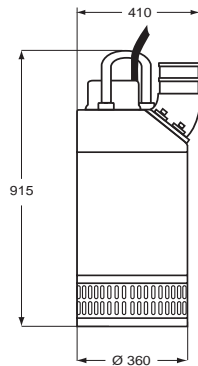

RL 6090

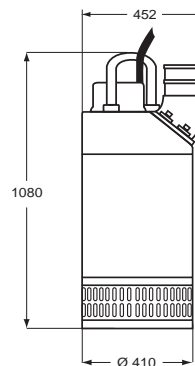

Dimension in mm.

RL 8010

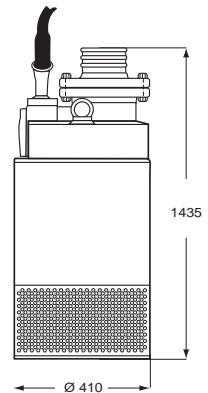

ORDER NUMBERS

Each WEDA PUMP RL model can be ordered in various configurations. You may refer to the below guidelines to order.

All denominations terminating in 2, 4 or 6 stand for 50 Hz models (for example RL 4152, RL 4154, RL 4156).
All denominations terminating in 3, 5 or 7 stand for 60 Hz models (for example RL 4153, RL 4155, RL 4157).

All denominations terminating in 2 or 3 stand for low-head pumps (for example RL 4152, RL 4153).
All denominations terminating in 4 or 5 stand for medium-head pumps (for example RL 4154, RL 4155).
All denominations terminating in 6 or 7 stand for high-head pumps (for example RL 4156, RL 4157).

RL 2010

The RL 2010 is an extremely light weight pump: 12.5 kg (excl. cable) **with a capacity as high as pumps that normally weigh between 18 and 33 kg in our competitor' range!** Trouble-free operation with service intervals every 6 months (service performed in a few minutes only) makes the RL 2010 **an ideal rental tool.**

Features:

The shaft seals are grease lubricated.

The pump seal consists in one radial lip seal (Simmer rings).

The motor seal consists in one radial lip seal (Simmer ring).

Both the pump seal and the motor seal are built in one complete unit of aluminium filled with grease.

The rotor shaft has a tungsten carbide wear sleeve rotating against the lip seals.

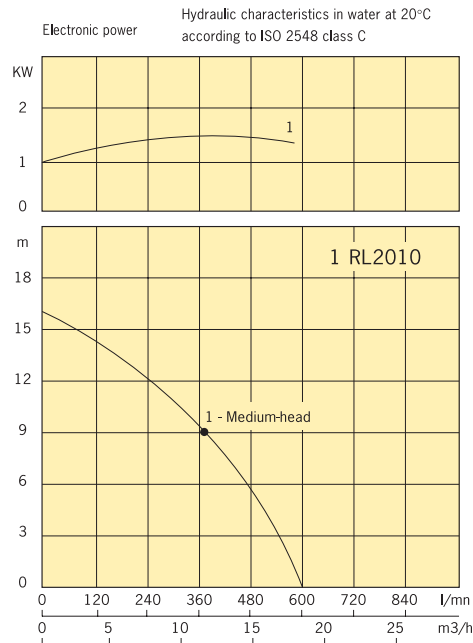

VOLTAGE		RATED CURRENT
110 V	1-phase	13.0 A
220-240 V	1-phase	6.4 A
220-240 V	3-phase	3.0 A
380-415 V	3-phase	2.0 A
500 V	3-phase	1.8 A

Other voltages upon request.

POWER CABLE STANDARDS

15 metres 3 x 2.5 mm² for 110 V, 1-phase.
 20 metres 3 x 1.5 mm² for 220-240 V, 1-phase.
 20 metres 4 x 1.5 mm² for other power supplies.
 All cables polychloroprene type HO7RN-F.



RL 2030

The RL 2030 combines the advantages of small pumps (lightweight) and those of bigger pumps (with dual mechanical shaft seal), therefore resulting in a compact design, but with the best possible performance and service- friendliness.

Features:

The shaft seals are oil lubricated.

The pump seal consists in two silicon carbide seals against each other.

The motor seal consists in one lip seal (Simmer ring).

The pump bearing consists in a deep groove single ball bearing, running in oil.

The top bearing is greased for life with high temperature grease and anti-corrosion additive.

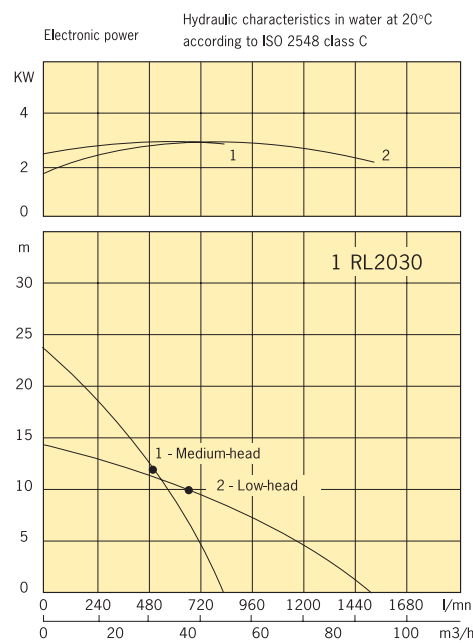

VOLTAGE		RATED CURRENT
220-240 V	1-phase	12.0 A
220-240 V	3-phase	7.3 A
380-415 V	3-phase	4.2 A

Other voltages upon request.

POWER CABLE STANDARDS

20 metres 3 x 2.5 mm² for 220-240 V, 1- and 3- phase.
 20 metres 4 x 1.5 mm² for other power supplies.
 All cables polychloroprene type HO7RN-F.



RL 4140

Built on the same principle as the RL 2030, the RL 4140 is a compact pump, lightweight: only 25 kg for a maximum capacity of 1600 l/mn, and a total head over 20 m. Highly reliable as compared to other pumps of the same category on the market, the RL 4140 is indeed a pump designed for professional use, with a constant focus on serviceability.

Features:

The seals are oil lubricated.

The pump seal consists in two silicon carbide seals against each other.

The motor seals consists in one lip seal (Simmer ring).

The pump bearing consists in a deep groove single ball bearing, running in oil.

The top bearing is greased for life with high temperature grease and anti-corrosion additive.

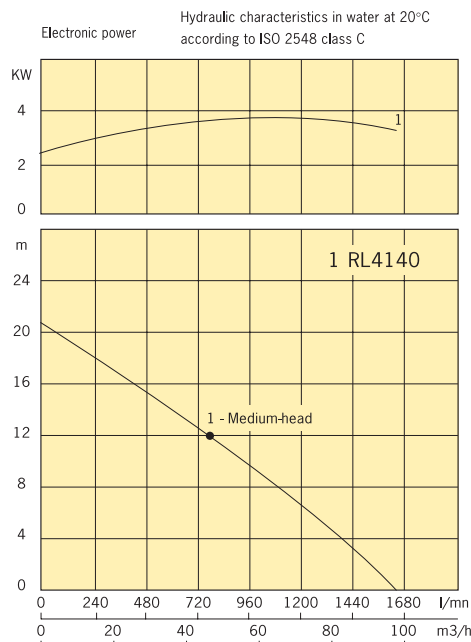

VOLTAGE		RATED CURRENT
220-240 V	3-phase	10 A
380-415 V	3-phase	5.3 A
Other voltages upon request.		
POWER CABLE STANDARDS		
20 metres 4 x 1.5 mm ² .		
All cables polychloroprene type HO7RN-F.		



RL 4150

The RL 4150 is designed for heavy-duty applications. It combines high capacity (3000 l/mn) and flexibility owing to the various impeller versions that can be adapted on the pump according to each site configuration. It is a genuine "plug-and-pump" model, very easy to install and featuring unattended operation as it can be equipped with a built-in NVB electronic level control device.

Features:

The seals are oil lubricated.

The pump seal consists in two silicon carbide seals against one another.

The motor seal consists in two silicon carbide seals against one another.

The pump bearing consists in a deep groove single ball bearing, running in oil.

The top bearing is greased for life with high temperature grease and anti-corrosion additive.

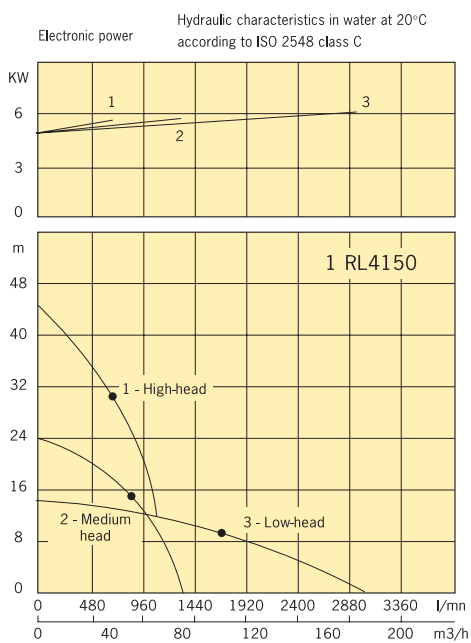

VOLTAGE		RATED CURRENT
220-240 V	3-phase	16.0 A
380-415 V	3-phase	8.5 A
Other voltages upon request.		
POWER CABLE STANDARDS		
20 metres 4 x 2.5 mm ² .		
20 metres 4 x 4 mm ² for 220 V.		
All cables polychloroprene type HO7RN-F.		



RL 4060

The RL 4060 is one of WEDA PUMP heavy-duty best sellers, especially in medium-head version. Many of our customers in the navy worldwide have selected this model with an epoxy-painting for its high capacity (3400 l/mn). This model is also particularly recommended for mining applications and big construction sites as it is really versatile owing to its various impeller versions. It is a genuine "plug-and-pump" model, very easy to install and self-starting as it can be equipped with a built-in NVB electronic level control device.

Features:

- The mechanical seals are oil lubricated.*
- The pump seal consists in two silicon carbide seals against one another.*
- The motor seal consists in two silicon carbide seals against one another.*
- The pump bearing consists in a deep groove single ball bearing, running in oil.*
- The top bearing is greased for life with high temperature grease and anti-corrosion additive.*

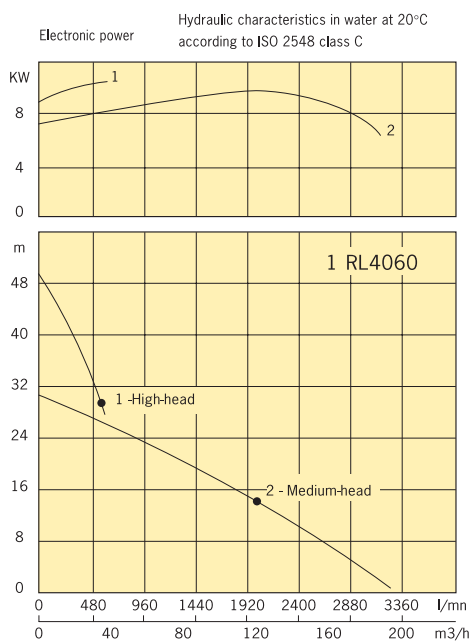

VOLTAGE		RATED CURRENT
220-240 V	3-phase	31.0 A
380-415 V	3-phase	16.0 A
Other voltages upon request.		
POWER CABLE STANDARDS		
20 metres 4 x 2.5 mm ²		
20 metres 4 x 4 mm ² for 220 V.		
All cables polychloroprene type HO7RN-F.		

RL 6070

The RL 6070 is designed for heavy-duty applications. It combines high capacity (4700 l/mn) and flexibility owing to the various impeller versions that can be mounted on the pump according to specific sites' requirements. It is a genuine "plug-and-pump" model, very easy to install and featuring unattended operation as it can be equipped with a built-in NVB electronic level control device. It can also be equipped with a delta/star starter.

Features:

- The mechanical seals are oil lubricated.*
- The pump seal consists in a tungsten carbide and a ceramic seal against one another.*
- The motor seal consists in a carbon and a ceramic seal against each another.*
- The pump bearing consists in two opposed angular contact ball bearings, running in oil.*
- The top bearing consists in a row ball bearing greased for life with high temperature grease and anti-corrosion additive.*

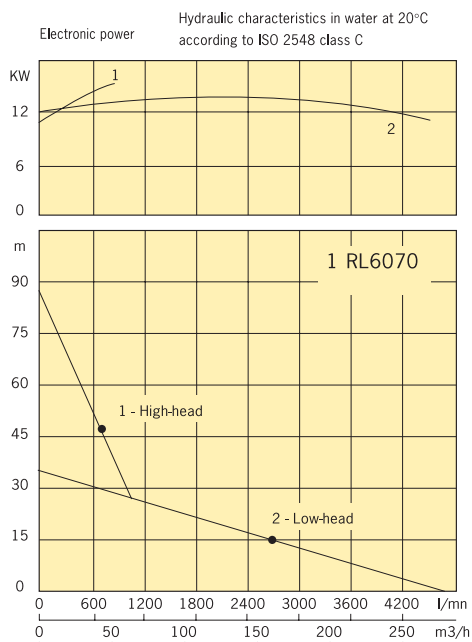

VOLTAGE		RATED CURRENT
220-240 V	3-phase	40.0 A
380-415 V	3-phase	23.0 A
500 V	3-phase	18.0 A
Other voltages upon request.		
POWER CABLE STANDARDS		
20 metres 4 x 4 mm ²		
20 metres 4 x 10 mm ² for 220-240 V.		
All cables polychloroprene type HO7RN-F.		

RL 6090

The RL 6090 is designed for heavy-duty professional applications. With a high capacity (max. 6300 l/mn) and a maximum total head as high as 45 m, the standard version also features over-current relay and delayed start. An optional delta/star starter can also be mounted on the RL 6090 pump.

Features:

The mechanical seals are oil lubricated.

The pump seal consists in tungsten carbide seal and a ceramic seal against one another.

The motor seal consists in a carbon seal and a silicon carbide seal against one another.

The pump bearing consists in two opposed angular contact ball bearings, running in oil.

The top bearing consists in a row ball bearing greased for life high temperature grease and anti-corrosion additive.

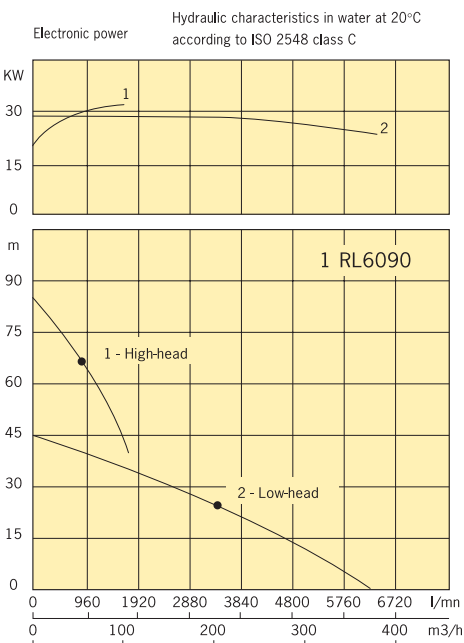

VOLTAGE		RATED CURRENT
220 V	3-phase	82.0 A
380 V	3-phase	46.0 A
415 V	3-phase	46.0 A
500 V	3-phase	38.0 A
Other voltages upon request.		
POWER CABLE STANDARDS		
20 metres 4 x 10 mm ² for 415-500 V		
20 metres 4 x 16 mm ² for 380 V		
20 metres 4 x 125 mm ² for 220 V		
All cables polychloroprene type HO7RN-F.		



RL 8010

The RL 8010 is WEDA PUMP's biggest model in our range of submersible pumps. It is used when really big volumes of water have to be moved (as much as 19000 l/mn). This model is equipped with a 4-pole motor (1450 RPM instead of 3000 for all other models). It does not have a built-in starter, but in order to meet end-users' requirements worldwide, WEDA PUMP supplies starter boxes as external equipment, according to customers' required configuration. Being our "jumbo" model, the RL 8010 has nevertheless been designed with service-friendliness in mind.

Features:

The mechanical seals are oil lubricated.

The pump seal consists in a tungsten carbide and a ceramic seal against one another.

The motor seal consists in a carbon seal and a silicon carbide seal against one another.

The pump bearing consists in two opposed angular contact ball bearings, running in oil.

The top bearing consists in a row ball bearing greased for life with high temperature grease and anti-corrosion additive.

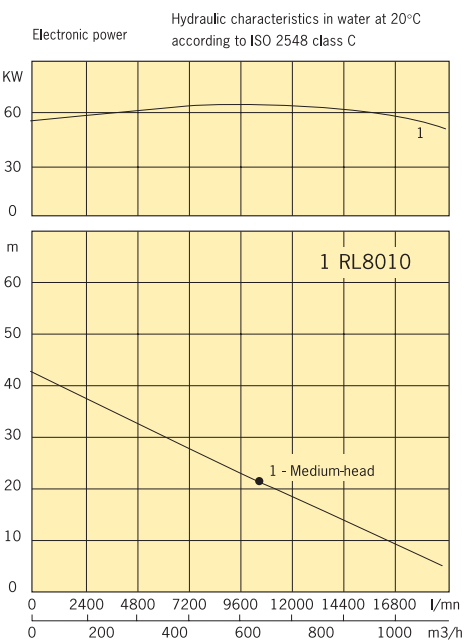

VOLTAGE		RATED CURRENT
380-400 V	3-phase	110 A
415 V	3-phase	100 A
500 V	3-phase	80
Other voltages upon request.		
POWER CABLE STANDARDS		
2 x 20 m 4 x 25 mm ²		
20 m 4 x 10 mm ² for thermistors.		



WEDA PUMP

Delta Pompen B.V. Rigaweg 17 9723 TE Groningen The Netherlands, Tel.: +31 (0)50-2072380

<http://www.wedapump.com> - info@deltapompen.com